

PROJECT: _____
 CATALOG #: _____
 FIXTURE TYPE: _____
 NOTES: _____

SALP M1

2.3" Slim Architectural Linear Pendant Mount

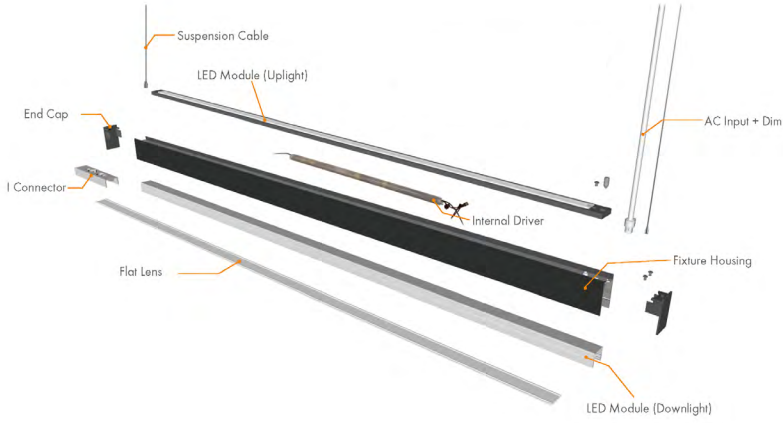

The SALP M1 2.3" Slim Architectural Linear Pendant Mount is an ultra-sleek lighting solution that is fully customizable to meet the unique needs of each application. The lengths come in 2 ft, 4 ft, and 8 ft with selectable color temperature, wattage, and distributions. The minimalist and elegant aesthetic paired with brilliant illumination and even distribution will elevate your space in a range of applications, including offices, lobbies, and retail spaces. This versatile architectural luminaire possesses unlimited design potential for endless design pattern possibilities.

BUILT TO ORDER

All orders are carefully assembled in Houston, TX, to meet the unique needs of each application and project.

APPLICATIONS

Commercial, Retail, Hospitality, Education, Airport, Medical, and any open spaces that require a unique and elegant architectural lighting design.



Due to continuous product improvements, specification and/or equipment updates may change without notice.

PRODUCT OPTIONS

DRIVER



Internal Driver

Selectable Distribution

LENS

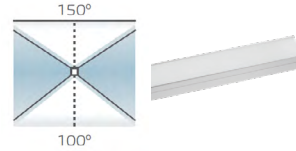

Flat Lens

SELECTABLE LIGHTING DISTRIBUTIONS

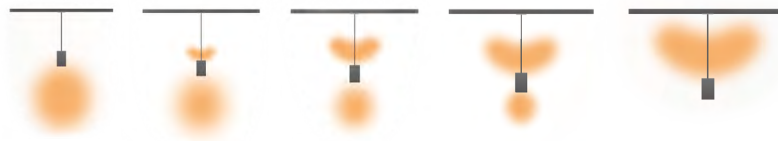

Direct

Semi-Direct

General Diffuse

Semi-Indirect

Indirect

CANOPY SIZE & SHAPE



1.6in Round



4.5in Round
Designed for
power cable

MOUNTING STYLES



Drywall Ceiling
w/ Internal Driver

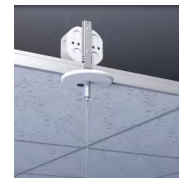

T-Grid Clips
Suspends luminaire in T-grid.
Compatible with 9/16" and
15/16" Flat, 9/16" and 15/16"
Slot Ceiling Types.

Due to continuous product improvements, specification and/or equipment updates may change without notice.

ORDERING GUIDE

The Ordering Guide is not complete without filling out the Layout Sketch located on page 6. If you have any questions, please contact sales.

Luminaire Type	Width	*Length	Lumen Per Ft	Internal Driver	Lens	Generation	CCT	Finish
SALP 2.3" Width Slim Architectural Linear Pendant Mount	M1 Medium 2.3"	# Total length needed. Increments of 2 feet only.	LS1 500lm/750lm/1000lm per ft	CSID Internal Driver with Selectable Distributions 100% up 90% down / 10% up 75% down / 25% up 50% down / 50% up 25% down / 75% up 10% down / 90% up 100% down	F Flat Lens	G1	FSK Field Selectable CCT 3000K/3500K/4000K	Blank White B Black C Custom Color

*Length: The SALP M1 is available in 2', 4', and 8' lengths that can be directly connected together in a continuous run up to 40' (120v) or 100' (277V). Please use the Layout Sketch on page 6 for full details.

MOUNTING

Ceiling Plan	Suspended Lengths
E Dry Wall (Mount to J-box) T1 Drop Ceiling Clips (Suitable for 9/16" and 15/16" Flat Ceiling) T2 Drop Ceiling Clips (Suitable for 9/16" Slot Ceiling) T3 Drop Ceiling Clips (Suitable for 15/16" Slot Ceiling)	60 60" Aircraft Cable with 48" Power Cord 144 144" Aircraft Cable with 144" Power Cord 240 240" Aircraft Cable with 240" Power Cord

ACCESSORIES (Shipped separately. Requires some field assembly.)
AVI-XFAC-16A-1CH-CL1 Wireless Circuit Load Controller
EMH 25W 25W Emergency Backup

PATTERN CONNECTORS

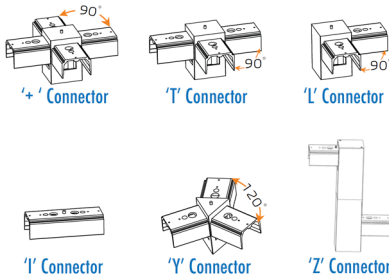

Connectors
X '+' Connector
T 'T' Connector
L 'L' Connector
I 'I' Connector
Y 'Y' Connector
Z 'Z' Connector

Due to continuous product improvements, specification and/or equipment updates may change without notice.

SPECIFICATIONS

HOUSING

Anodized aluminum extruded body

AMBIENT TEMPERATURE

Suitable for use in 0°C to 40°C (32°F to 104°F)

MOUNTING

Pendant Mount

EFFICACY

Up to 100 Lm/W

ELECTRIC

120V for connections up to 40ft.

277V for connections up to 100ft.

Standard 1-10V Dimming.

Power factor >0.9, THD <20%.

CCT AND CRI

Selectable 3000K/3500K/4000K CCT; Standard 80 CRI.

LENS

Standard Flat Lens

FINISH

Standard White and Black housing in stock. Custom finishes available.

WARRANTY

5-year limited warranty. Please visit www.slgus.com for complete warranty terms.

CERTIFICATIONS

UL Listed for damp location.

DIMENSIONS

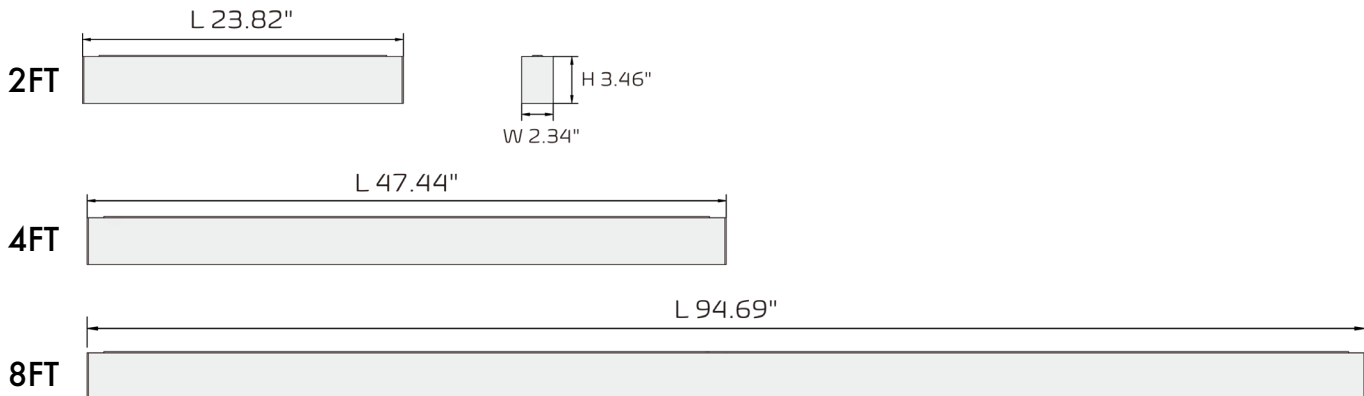

Product number	Weight
SALP M1 4 LS1 CSID F G1 FSK	6.44 lbs
SALP M1 8 LS1 CSID F G1 FSK	12.46 lbs
SALP M1-C-LC	1 lbs
SALP-DW-WP-KIT	3 lbs
SALP-DW-WP-KIT-T1	3.2 lbs
EMH-25	6.3 lbs

Due to continuous product improvements, specification and/or equipment updates may change without notice.

PHOTOMETRIC

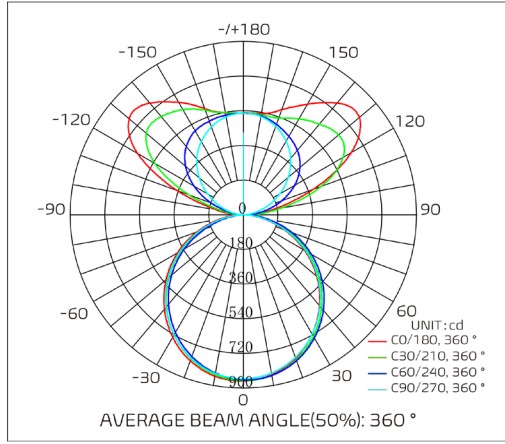

AVERAGE ILLUMINANCE CURVE

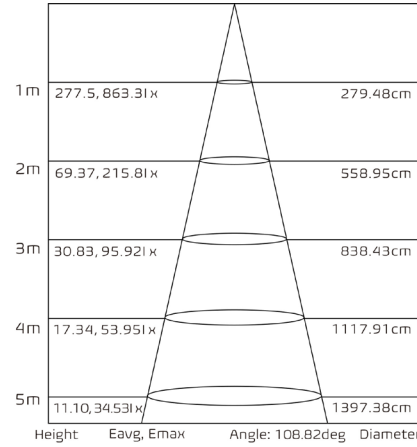

Note: The Curves indicate the illuminated area and the average illumination when the luminaire is at different distance.

ZONAL FLUX DIAGRAM

T	C0	C45	C90	C135	C180	C225	C270	C315
5	857.7	858.1	847.3	841.0	861.4	853.7	848.1	856.1
10	844.1	849.1	835.1	821.8	851.1	839.3	837.7	851.1
15	822.1	831.6	815.6	795.4	833.5	817.4	819.0	839.8
20	792.8	807.2	788.8	762.5	807.4	788.9	792.8	820.2
25	757.1	775.5	755.5	723.0	774.6	753.2	760.5	793.2
30	716.2	737.2	715.9	677.7	735.6	711.7	721.7	759.2
35	667.9	693.4	670.2	627.5	690.3	664.2	676.4	719.2
40	616.1	644.0	619.9	572.8	639.9	611.7	626.2	673.2
45	559.4	589.1	564.3	513.7	585.0	554.8	571.2	621.7
50	499.2	530.9	505.0	451.3	525.8	493.6	511.7	565.9
55	434.1	468.3	441.5	385.1	462.7	428.4	448.0	505.6
60	365.3	402.1	374.7	315.6	395.8	360.6	381.1	441.0
65	295.4	332.9	305.0	244.5	326.8	289.8	310.4	373.2
70	224.4	260.6	232.0	174.7	254.3	217.5	238.4	302.7
75	154.3	189.1	161.3	108.6	184.1	147.3	166.8	230.2
80	90.07	120.5	95.53	51.77	117.0	83.82	99.31	159.1
85	36.95	60.98	41.01	10.68	58.12	32.86	43.08	93.01
90	39.69	49.44	5.334	21.91	41.89	11.80	5.515	61.74

DEG LUMINOUS INTENSITY:cd

ZONAL LUMEN SUMMARY

T	φ zone	φ total	%lum,lamp
0-5	20.42	20.42	0.43,0.43
5-10	60.56	80.98	1.71,1.71
10-15	98.57	179.6	3.79,3.79
15-20	133.1	312.7	6.6,6.6
20-25	163.1	475.8	10,10
25-30	187.6	663.4	14,14
30-35	205.7	869.1	18.3,18.3
35-40	217.0	1086	22.9,22.9
40-45	221.2	1307	27.6,27.6
45-50	218.2	1525	32.2,32.2
50-55	207.9	1733	36.6,36.6
55-60	190.9	1924	40.6,40.6
60-65	167.5	2092	44.1,44.1
65-70	138.6	2230	47.1,47.1
70-75	105.8	2336	49.3,49.3
75-80	71.76	2408	50.8,50.8
80-85	39.81	2448	51.7,51.7
85-90	18.41	2466	52,52

UNIT: lm

COEFFICIENTS OF UTILIZATION

ppc	80%			70%			50%			30%			10%			0
	50%	30%	10%	50%	30%	10%	50%	30%	•••••	50%	30%	10%	50%	30%	10%	0
pfc	20%			20%			20%			20%			20%			0
RCR	RCR:Room Cavity Ratio						(CU)									
0.0	108	108	108	0	0	0	84	84	84	71	71	71	58	58	58	52
1.0	94	90	86	87	83	80	74	71	69	62	60	58	51	50	48	43
2.0	81	75	70	75	70	65	64	60	57	54	51	48	44	42	40	36
3.0	71	64	58	66	60	54	57	51	47	48	44	41	39	37	34	30
4.0	63	55	49	59	51	46	50	45	40	42	38	32	35	32	29	26
5.0	56	48	42	52	45	39	45	39	35	38	33	30	31	28	25	22
6.0	50	42	36	47	39	34	40	34	30	34	30	26	28	25	22	19
7.0	45	37	32	42	35	30	36	31	26	31	26	23	26	22	20	17
8.0	41	33	28	38	31	26	33	27	23	28	24	20	24	20	18	15
9.0	37	30	25	35	28	23	30	25	21	26	22	18	22	18	16	14
10.0	34	27	22	32	26	21	28	23	19	24	20	17	20	17	14	12

Due to continuous product improvements, specification and/or equipment updates may change without notice.

