

DGS G1

LED Gimbal Swivel Downlight Gen 1 **DESIGN XP**

Due to continuous product improvements, specification and/or equipment updates may change without notice.



SIDE VIEW



FRONT VIEW



TOP VIEW

DGS 4R 4" Swivel Gimbal

Selectable Driver

(Images are shown for illustration purposes only)

The DGS LED Gimbal Swivel Downlight offers a smooth, pure light with a full 360° rotation and up to 90° tilt, perfect for design and functionality. A great retrofit or new-construction lighting solution with an impressive 90 CRI and 5 selectable CCT outputs, giving your customer the freedom of last minute changes, future-proof investment, and a perfect stocking solution.

CATALOGUE

Catalog Number	Description	Lumens	Watts	CCT SELECTABLE	Voltage
DGS 4R 9 D38 G1 9FSK	4" Round LED Swivel Gimbal Downlight - 38° Beam Angle - 90 CRI	900 Lm	12 W	2700K - 5000K	120V

ORDER GUIDE

Luminaire Type	Size	Lumen Output	Optics	Generation	Voltage	Selectable CCT and CRI	Finish	Options - Emergency Backup	Accessories (Ships Separately)
• DGS Gimbal Swivel Downlight	• 4R 4" ROUND	• 9 900 Lumens / 12W	• D38 38° Beam Angle	• G1 1st Generation	• BLANK 120V	• 9FSK 90 CRI - 2700K 3000K 3500K 4000K 5000K	• BLANK Matte White	• BLANK No backup. • EMA-DH20T- UNV-110 Emergency battery backup	• BLANK No accessories. • DE 3/4/6/8/10R HOUSING ENew Construction Universal Housing. • DT GR 4R W 4" Goof Ring for 4" Downlights.

SPECIFICATIONS

Housing

Die-casting aluminum housing.

Rotation & Tilt

360° Rotation & 90° Tilt

Operate Temperature

-25° C to 40° C (-13° F to 104° F).

Electrical

50/60 Hz

CCT and CRI

2700K, 3000K, 3500K, 4000K, and 5000K
90 CRI

Lumen Output

900 Lm

Wattage

12W

Optics

38° beam angle

Input Voltage

TRIAC/ELV driver 120V

Dimming

TRIAC 10-100%

Mounting

Recessed, Canless

Warranty

5-year limited warranty. Comprehensive warranty terms can be located on www.slgus.com.

Certifications

Energy Star pending. ETL listed - Suitable for Wet Locations. FCC compliant. Certified to California T24 JA8 and T20 requirements

PERFORMANCE

Series Number	Lumens	Wattage	SELECTABLE CCT
DGS 4R 9 D38 G1 9FSK	900 Lm	12 W	2700K/3000K/3500K/4000K/5000K

DIMENSIONS

4in Round

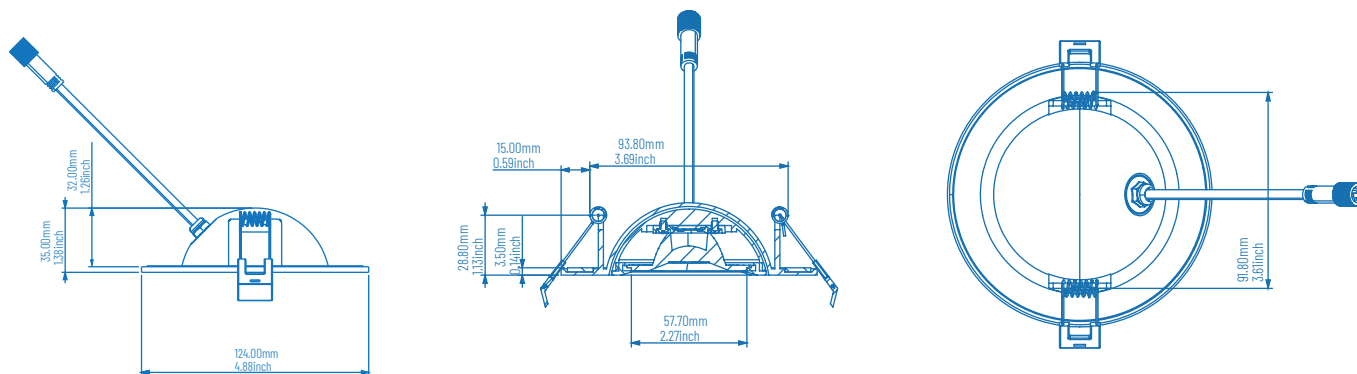

J-BOX

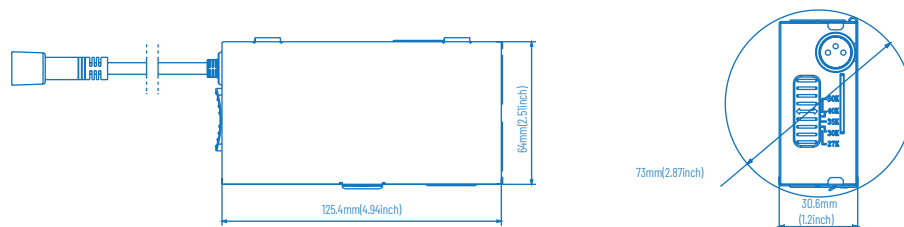

PHOTOMETRIC

4in Round 12W 120V 3000K CRI90

DATA OF LAMP		PHOTOMETRIC DATA			EFF: 98.53 lm/W
MODEL		I _{max} (cd)	2205	S/MH (C0/180)	0.61
NOMINAL POWER (W)	13	LOR (%)	100.0	S/MH (C90/270)	0.61
RATED VOLTAGE (V)	120	TOTAL FLUX (lm)	1147.6	η UP, DN (C0-180)	0.0, 59.5
NOMINAL FLUX (lm)	1147.62	CIE CLASS	DIRECT	η UP, DN (C180-360)	0.0, 46.5
LAMPS INSIDE	1	η up (%)	0.0	CIBSE SHR NOM	0.50
TEST VOLTAGE (V)	120	η down (%)	100.0	CIBSE SHR MAX	0.65

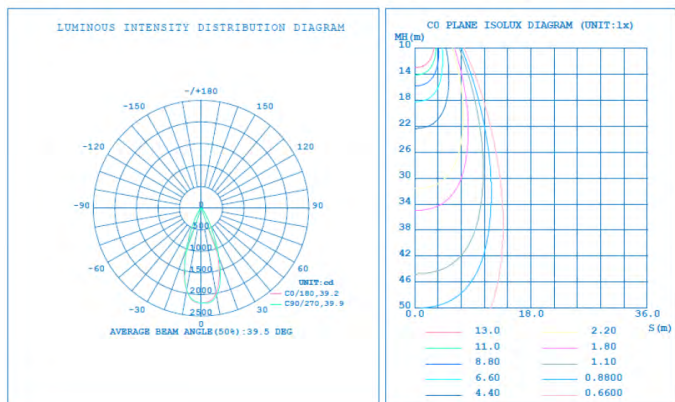

ACCESSORIES



EMA-DH20T-UNV-110

Product Specifications			
Input Voltage	100-277V AC, 50/60Hz	Output Voltage	110V AC
Input Current (Max)	100mA	Warranty	5 Years
Input Power (Max)	7 W	Output Power	20 W
Emergency Time	90 Minutes	Battery Type	Lithium
Charging Time	≥ 24 Hours	Ambient Temp	5°C - 50°C (41°F - 122°F)

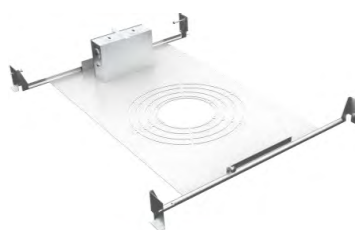

DE 3/4/6/8/10R HOUSING



DT GR 4R W

INSTALLATION DIAGRAM

Fig: 1

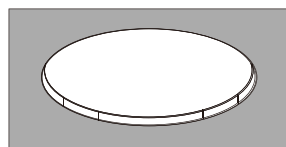

Fig: 2

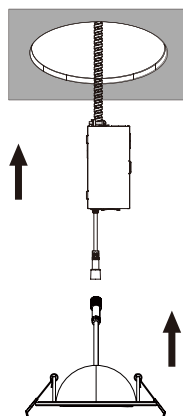

Fig: 3

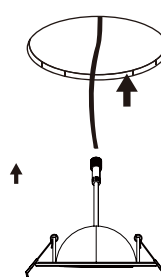

Fig: 4

